

BUDYNEK B
BIBLIOTEKA

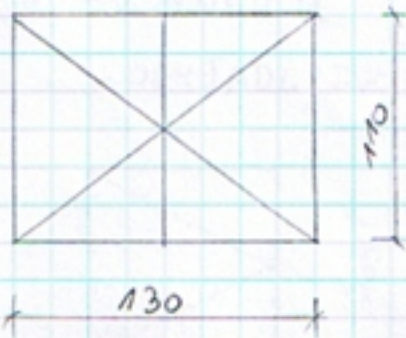

2 SZT
PARAPETY WEWNĘTRZNE

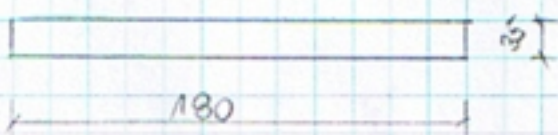

12 SZT
PARAPET WEWNĘTRZNY

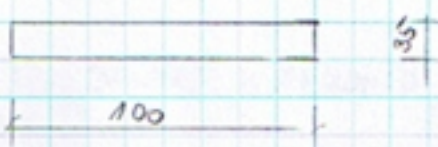

2 SZT
PARAPET WEWNĘTRZNY

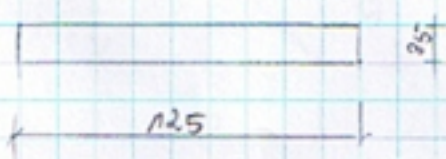

3 SZT
PARAPET WEWNĘTRZNY

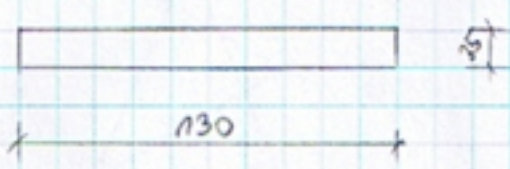

2 SZT
PARAPET WEWNĘTRZNY

VAT 22% SAPIEZYŃ 23 - ŚWIETLICA

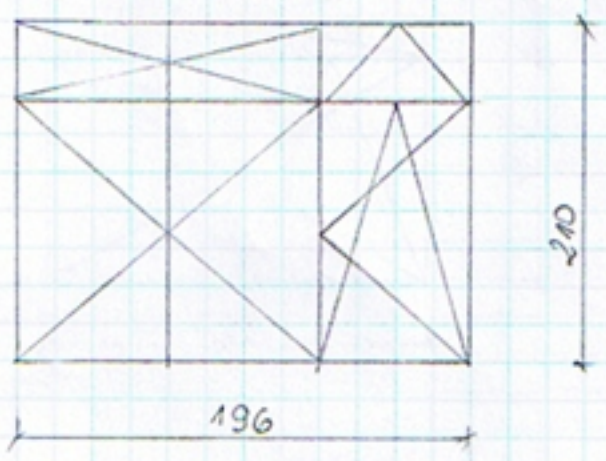

352T
+ PARAPET WĘWNETRZNY

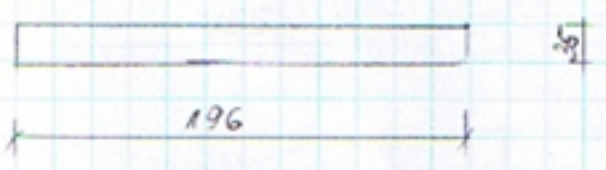

352T
PARAPET WĘWNETRZNY

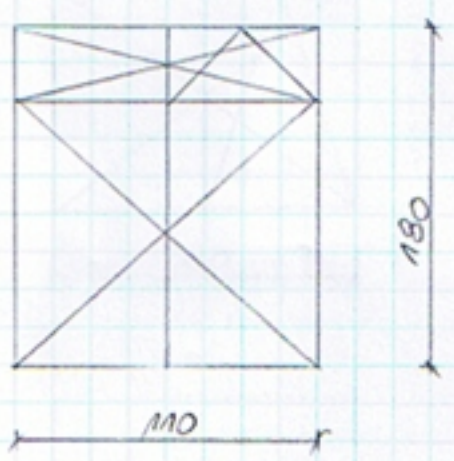

152T
+ PARAPET WĘWNETRZNY

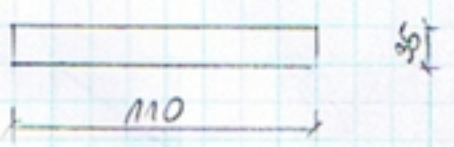

152T
PARAPET WĘWNETRZNY

VAT 22%

OLN DO WYMIANY
SZKOLA BORBECICE

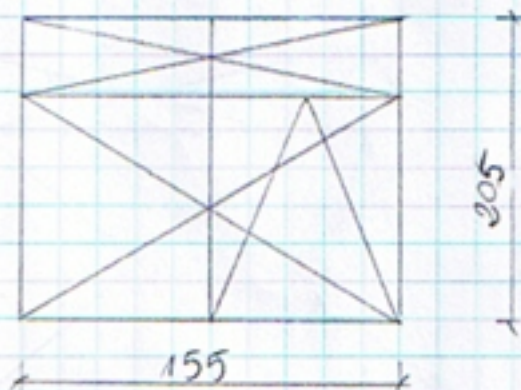

2 SZT
+ PARAPETY WEWNĘTRZNE

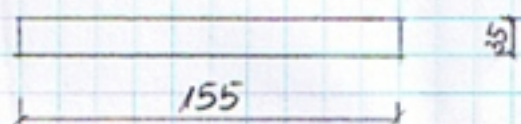

2 SZT
PARAPET WEWNĘTRZNY

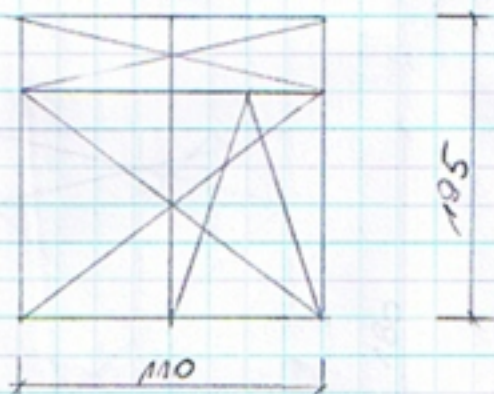

7 SZT
+ PARAPETY WEWNĘTRZNE

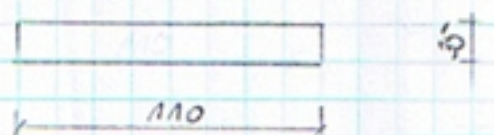

7 SZT
PARAPET WEWNĘTRZNY

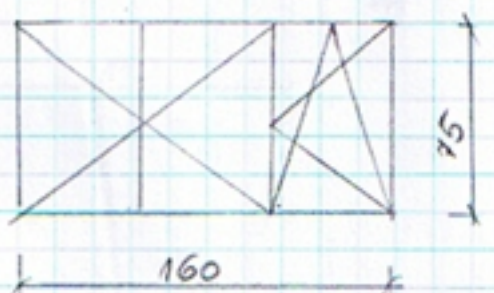

1 SZT
+ PARAPET WEWNĘTRZNY

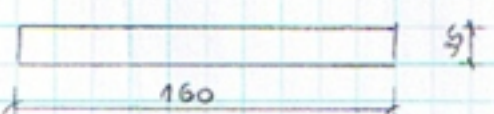

1 SZT
PARAPET WEWNĘTRZNY

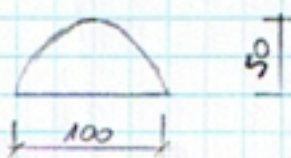

3 SZT
BEZ PARAPETÓW

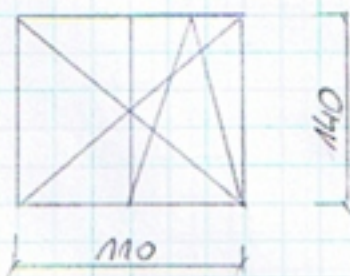

1 SZT
BEZ PARAPETU

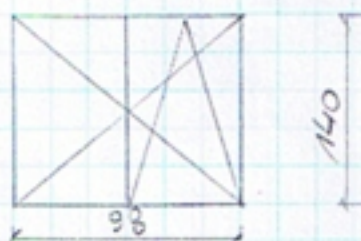

2 SZT
+ PARAPETY WEWNĘTRZNE

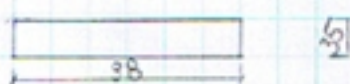

2 SZT PARAPETY WEWNĘTRZNE

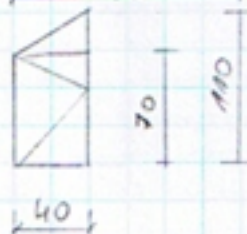

1 SZT
+ PARAPET WEWNĘTRZNY

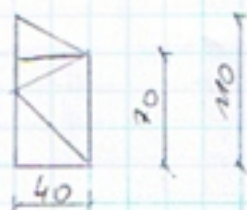

1 SZT
+ PARAPET WEWNĘTRZNY

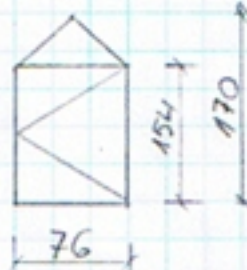

1 SZT
+ PARAPET WEWNĘTRZNY

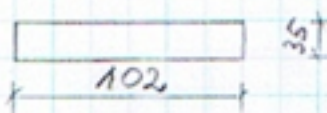

1 SZT - PARAPET WEWNĘTRZNY

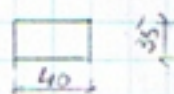

2 SZT - PARAPETY WEWNĘTRZNE

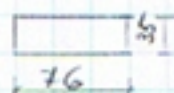

1 SZT - PARAPET WEWNĘTRZNY

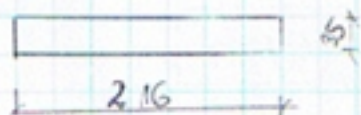

1 SZT PARAPET WEWNĘTRZNY

ZESPÓŁ SŁOŃNO - PODSIŁACZNY W PODZĘCIELNACH

KUCHNIA

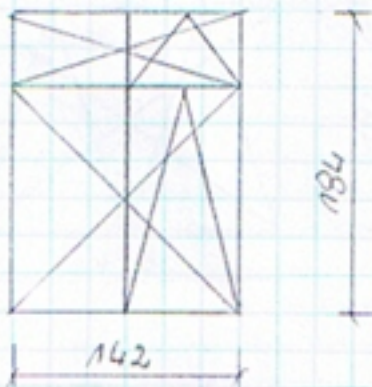

1 SZT
 + PARAPET WEWNĘTRZNY
 + NAWIĘZANIE

SALA

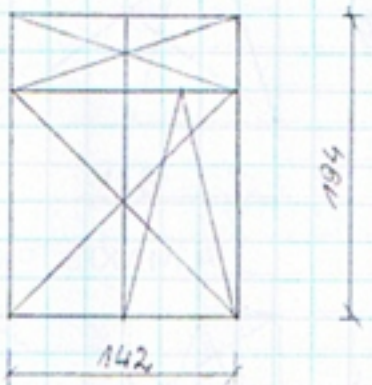

1 SZT
 + PARAPET WEWNĘTRZNY

SALA

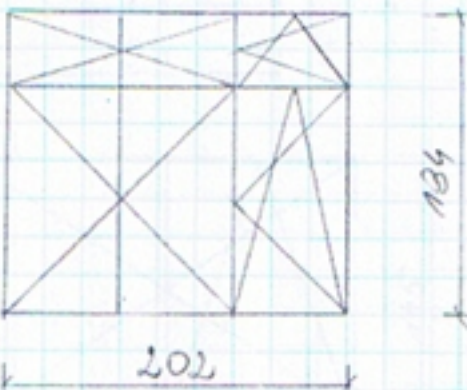

2 SZT
 + PARAPET WEWNĘTRZNY

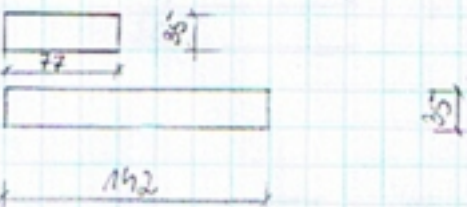

2 SZT. PARAPETY WEWNĘTRZNE
 2 SZT
 PARAPETY WEWNĘTRZNE

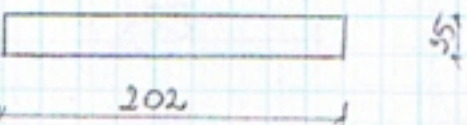

2 SZT
 PARAPETY WEWNĘTRZNE

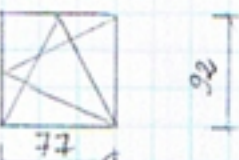

2 SZT + PARAPETY WEWNĘTRZNE

SIŁWA PODSTAWOWA W MOKROZMIE

KUCHNIA

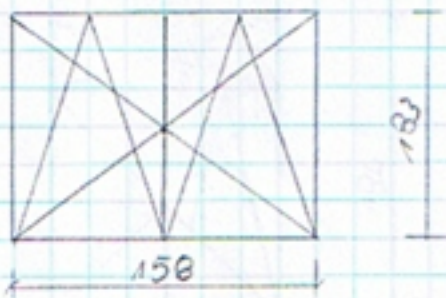

2 S2T
+ PARAPETY WEWNĘTRZNE
+ PRAWIETDZIAŁY

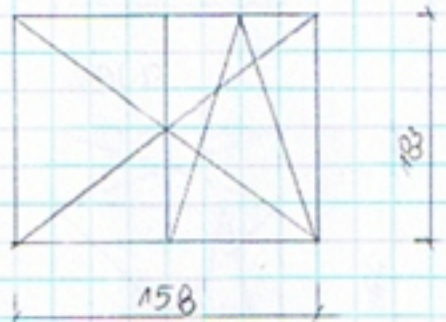

12 S2T + PARAPETY WEWNĘTRZNE
(SICRYTUA, STOLEWICA, MISCUKANIE)

KOTŁOWNIA

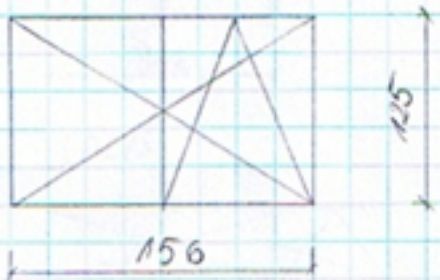

2 S2T
BEZ PARAPETÓW

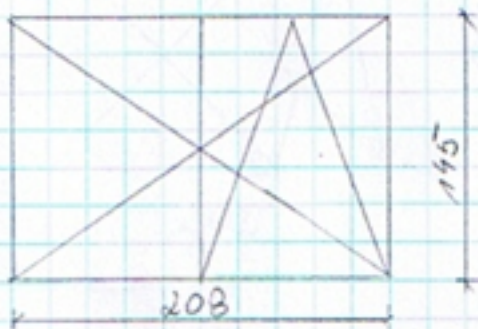

3 S2T
BEZ PARAPETÓW
(KORYTARZ, SWIETLICA + BIBLIOTEKA)

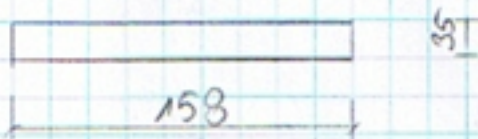

14 S2T
PARAPETY WEWNĘTRZNE