

1. BUDYNEK A

KORYTARZ

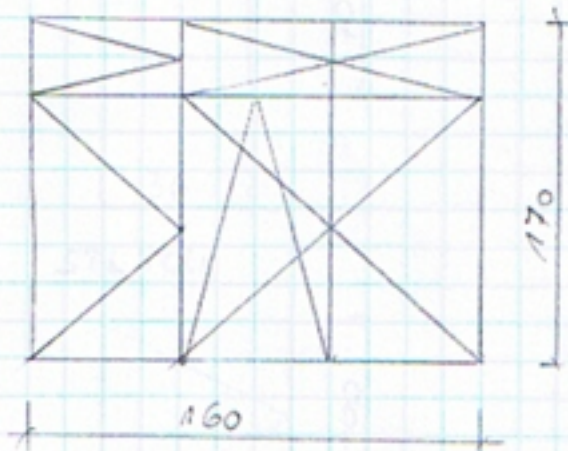

12 SZT
2 SZT PARAPETÓW

1 SZT
+ PARAPET WEWNĘTRZNY

1 SZT
5 SZT PARAPETÓW

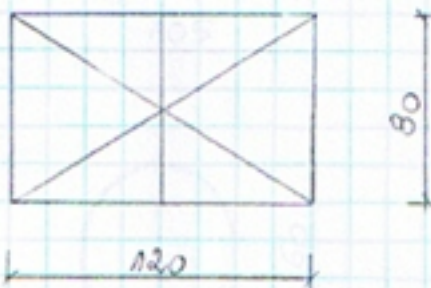

1 SZT
+ PARAPET WEWNĘTRZNY

1 SZT
5 SZT PARAPETÓW

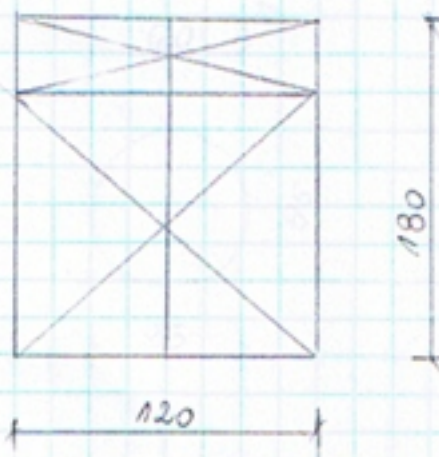

1 SZT
+ PARAPET WEWNĘTRZNY

POMIESZCZENIA NA GÓRZE

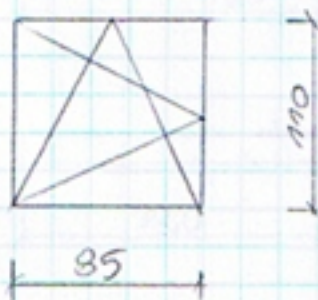

2 SZT
+ PARAPET WEWNĘTRZNY

2 SZT
5 SZT PARAPETÓW

1. BUDYNK/A

POMIESZCZENIA GÓRNE

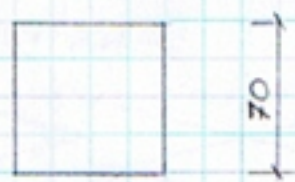

12 SZT
BEZ PARAPETÓW

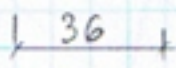

STRZYCLI

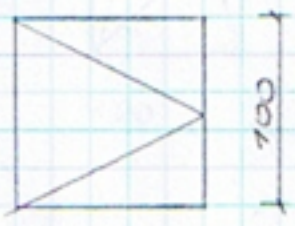

1 SZT
BEZ PARAPETU

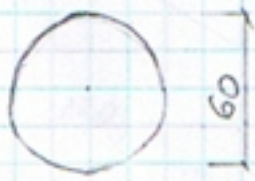
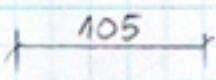

1 SZT
BEZ PARAPETÓW

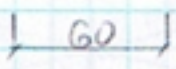

2 SZT
BEZ PARAPETÓW

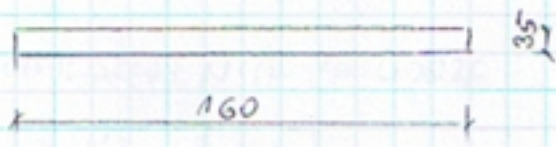
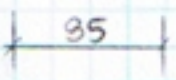

1 SZT PARAPET WĘWNETRZNY

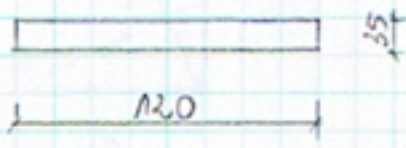

2 SZT PARAPET WĘWNETRZNY

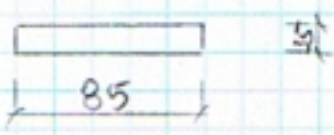

2 SZT PARAPET WĘWNETRZNY

1. BUDYNIEC

KORYTARZ DŁG

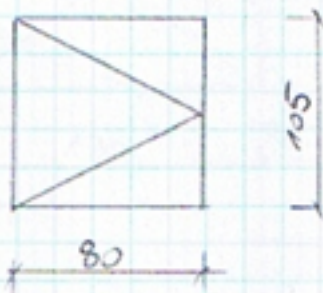

1 SZT
+ PARAPET WEWNĘTRZNY

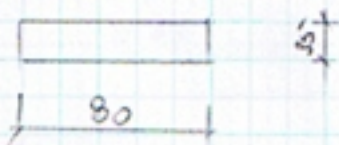

1 SZT
PARAPET WEWNĘTRZNY

DAWNA KOTŁOWNIA I STOKOWICA

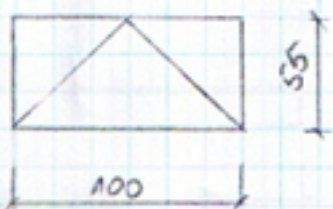

3 SZT
BEZ PARAPETÓW

KUCHNIA

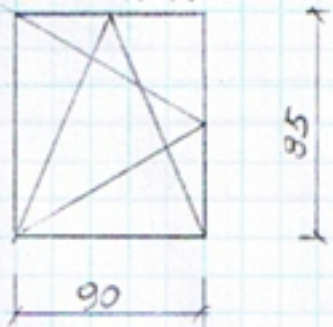

3 SZT
BEZ PARAPETÓW

VAT 2290

SZKOŁA PODSTAWOWA NR 20 W LINIU M

2. ŁAZNICA

SZATNIA

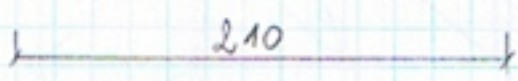
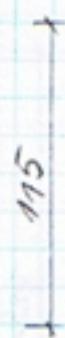
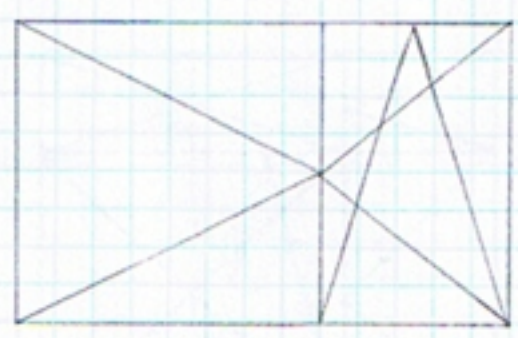

2 SZT
+ PARAPETY WEWNĘTRZNE

POKÓJ NAUCZYCIELSKA

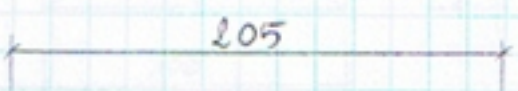
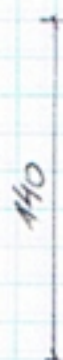
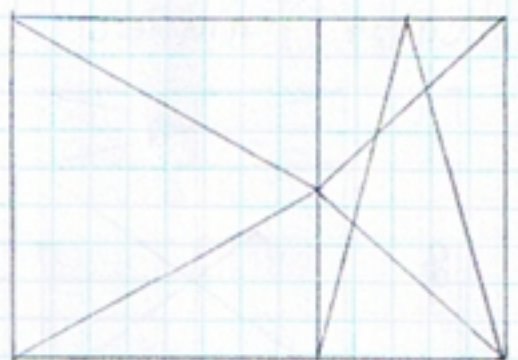

2 SZT
+ PARAPETY WEWNĘTRZNE

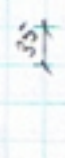
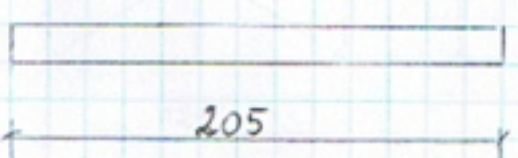
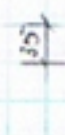
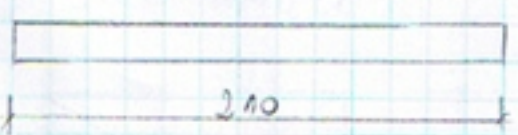

2 SZT
PARAPETY WEWNĘTRZNE

2 SZT
PARAPETY WEWNĘTRZNE

VAT 22% SZKOŁA PODSTAWOWA NR 1 M. GUNIK M.

3. BUDYNEK B

KLASY NR M, 17, 14, 16

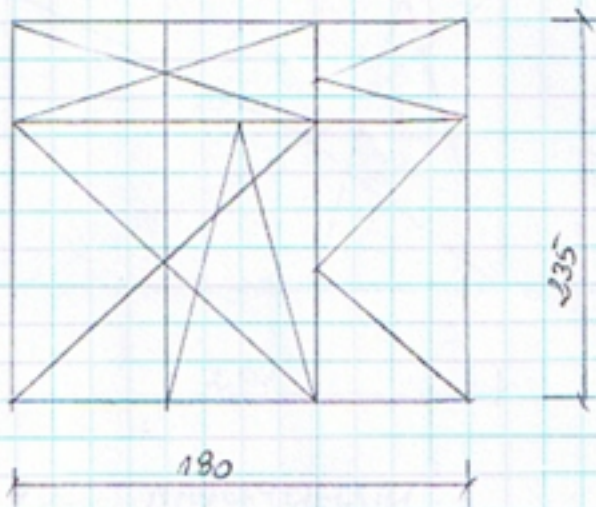

12 SZT
+ PARAPETY WEWNĘTRZNE

SZATNIA (I PĘTPO)

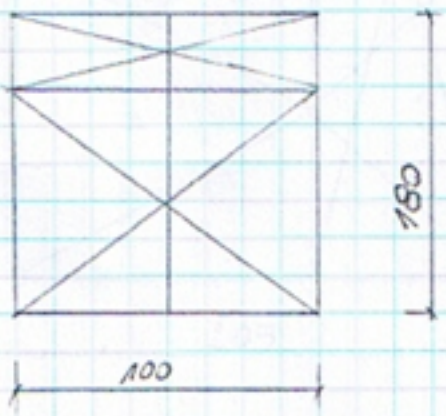

2 SZT
+ PARAPETY WEWNĘTRZNE

SALA PAMIĘCI

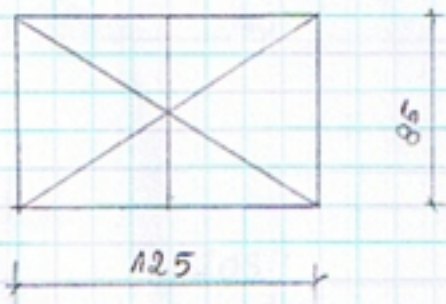

3 SZT
+ PARAPETY WEWNĘTRZNE